

SONY 
TILTA FOR SONY A793 RIG
A7SIII

TILTA

使用手册
INSTRUCTION MANUAL

TILTA FOR SONY A7S3 RIG

A7SIII

TILTA | TILTAING

SONY A7SIII RIG

[套件分解说明]

■ 全笼细节展示 ///

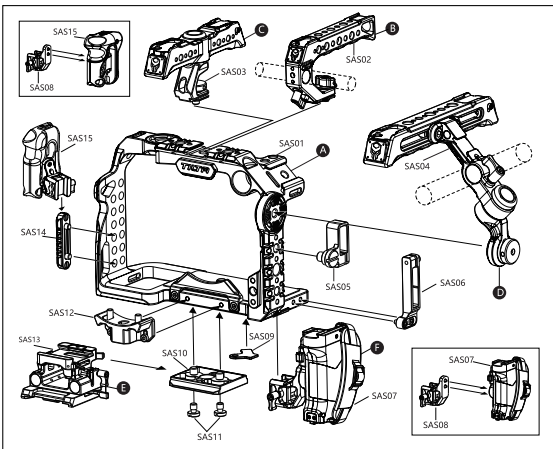
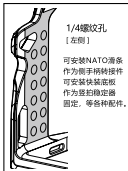
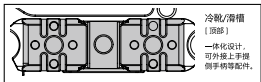

其他配件细节展示 ///

/// 其他配件细节展示

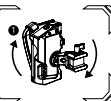
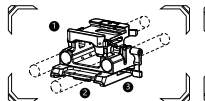
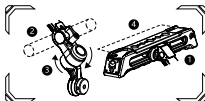
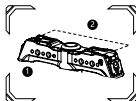
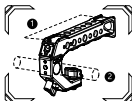

- ① 15mm导轨适配孔。
- ② 前后双冷却槽, 带保险限位设计。

B 通用上手提

- ① 可旋转90°切换为横握把。
- ② 前后双冷却槽, 带保险限位设计。

C 简易上手提

- ① 可前后调整握把位置。
- ② 有15mm导轨孔。
- ③ 手柄可横竖拍快速切换。
- ④ 顶部前后双冷却槽, 带保险限位设计。

D 按钮上手提

- ① 底座顶部为高规格设计。
- ② 有15mm导轨孔。
- ③ 底座兼容TILTA 15mm底座板。

E 底座

- ① 可360°调节角度。

F 录制手柄+转接件

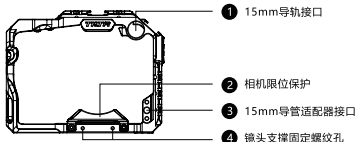

<正面>

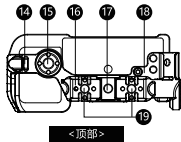

<顶部>

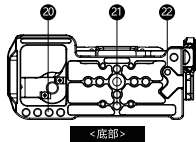

<底部>

- 5 腕带接口
6 1/4螺纹孔 [可在竖排模式下安装云台快装板]
7 冷靴接口 [可接话筒/补光灯等冷靴扩展配件]
8 安全带接口
9 标准阿莱牙盘扩展卡件 [可接旋转手柄/延长手柄等配件]
10 1/4定位螺纹口 [可接HDMI固定卡件]
11 标准阿莱定位孔
12 NATO滑条 [可接上手提/测手柄等配件]
13 TYPE-C线夹固定螺纹孔

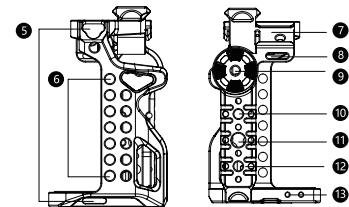

<左侧背>

<右侧背>

安装演示

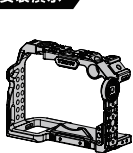

将索尼A7S3装入笼子, 1

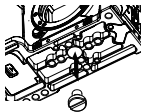

2 取出一字螺丝, 将螺丝装进机身底部的安装孔。

3 取出吸附在笼子底部的螺丝扳手, 拧紧螺丝即可完成装配。

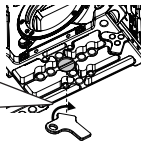

螺丝扳手可磁吸附于底部内, 方便携带。

安装演示

简易上手提

[选配]

根据不同场景和画面，按动顶部按钮可快速切换纵向与横向握把方向。



将上手提对应滑入笼子顶部冷靴槽中的1/4定位孔。 **1**



接入上手提后转动手扭锁紧螺丝即完成装配。 **2**

功能演示

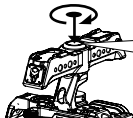

向下按动
旋转90°
可切换为
横向握把



通用上手提

[选配]

独特的冷靴螺杆式设计，稳定快速装配于机身。



将上手提对应滑入笼子顶部冷靴槽中的1/4定位孔。 **1**

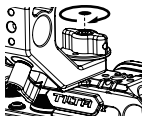

接入上手提后转动手扭锁紧螺丝即完成装配。 **2**

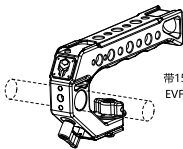

带15mm导轨适配孔位，可装载EVF支架并扩展各类支撑附件。

按钮上手提

[选配]

根据不同场景和画面，可通过旋转手提实现横/竖拍摄，专业便捷。

1

将上手提对接在全笼右侧臂上ARRI牙盘处。

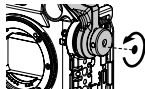

2

接入上手提后转动手扭锁紧螺丝即完成装配。

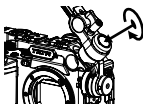

向下按压旋转90°，可调整手柄方位，变换各种形态。

[180°竖拍模式]
旋转180°，从手提切换成手柄。

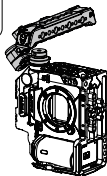
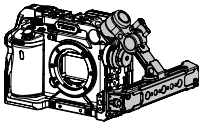

滑条安装演示

- 1** 将滑条对应笼子左侧臂上1/4定位螺纹孔。

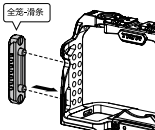

- 2** 对应后拧紧螺丝即可完成装配。

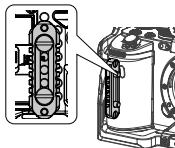

HDMI线夹和数据线线夹安装演示

- 1** 将HDMI线夹和数据线线夹对应笼子右侧臂滑槽上1/4定位螺纹孔。

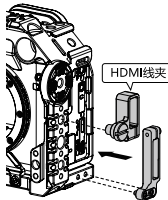

- 2** 对应后拧紧螺丝即可完成装配。

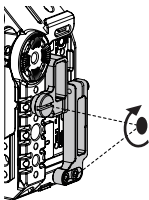

录制手柄和NATO滑条转接件安装演示

- 1** 对准手柄的1/4螺丝孔安装NATO滑条转接件。

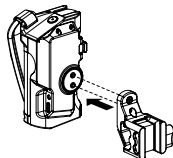

按压按钮后手柄可360°调节角度

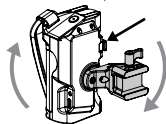

- 2**

先松开Nato滑条转接件手扭，将手柄完全滑入右侧滑条。



- 3**

滑入滑条后拧紧手扭即可完成装配。

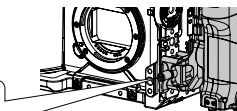
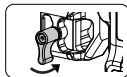

录制手柄是稳定type-c 8V、DC OUT 12V常规输出接口。外接设备请按照设备额定电压操作,如因不规范操作造成设备损坏,自行承担。

木质手柄和冷靴安装演示

1

先松开Nato滑条
转接件手扭，将
手柄完全滑入右
侧滑条。

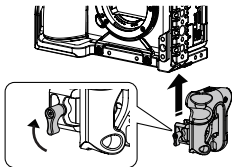

2

滑入滑条后拧紧手扭
即可完成装配。

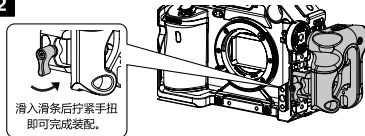

3

将冷靴对应木质手柄顶部
的1/4定位螺纹孔。

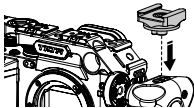

4

对应后拧紧螺丝即可完成
装配。



快板和底座安装演示

1

对应笼子底部的的1/4
定位螺纹孔安装通用
底座滑板。

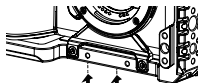

底部同样可接<阿卡快板>和
<曼富图快板>，安装方式和
滑板一致。

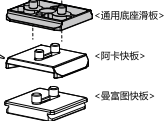

2

对应后拧紧螺丝即可
完成装配。

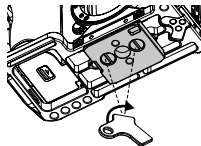





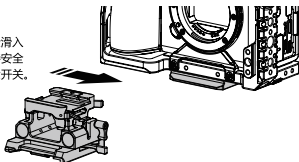



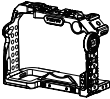







3

将底座完全滑入
滑板里，待安全
销弹起锁紧开关。



//// 以下配件可根据需求配合全笼自主搭配

 <p>TA-T18-FCC 全笼</p>	 <p>TA-QRTH 通用上手提</p>	 <p>TA-QRTH5 简易上手提</p>	 <p>TA-QRTH4 按钮上手提</p>
 <p>TA-LRH-57 / TA-AHA6-L 录制手柄</p>	 <p>TA-RWH / TA-AHA6-R 木质手柄</p>	 <p>TA-T18-CC2 HDMI线夹</p>	 <p>TA-T18-CC1 数据线线夹</p>
 <p>TA-SRA-15 侧臂单孔卡件</p>	 <p>TA-BSP2-15 15mm通用底座</p>	 <p>TA-T37-LAS 镜头转接环支撑</p>	 <p>TA-NRA-36 滑条</p>
 <p>TA-T18-BP 通用底座滑板</p>	 <p>TA-T18-QRBP3 曼富图快板</p>	 <p>TA-T18-QRBP4 阿卡快板</p>	 <p>TA-CSR 冷靴</p>

SONY A7SIII RIG

[CAGE MANUAL]

A FULL CAGE DETAILED DEMONSTRATION

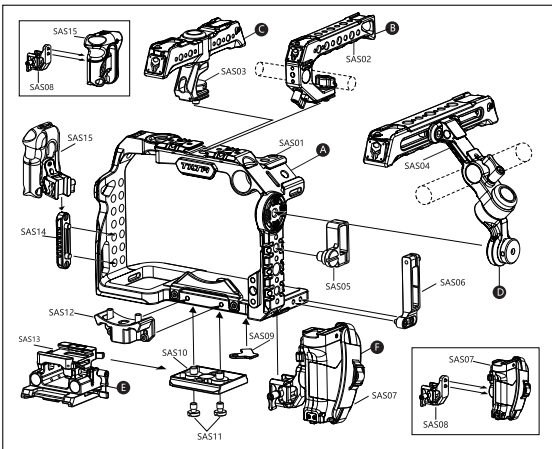
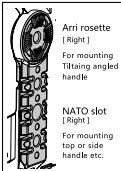
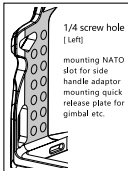
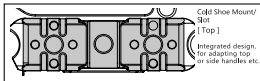
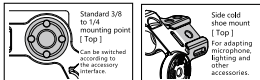

ACCESSORIES

ACCESSORIES

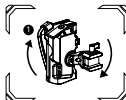
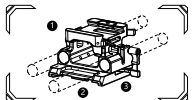
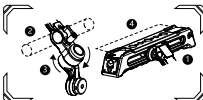
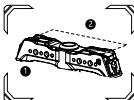
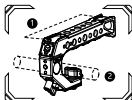

1 15mm rod mounting hole, for mounting support accessories.
2 Front and back double cold shoe mount with stop block.

B Universal Top Handle

1 Spin 90 degrees to switch to horizontal position.
2 Front and back double cold shoe mount with stop block.

C Standard Top Handle

1 Handle can be moved forwards or backwards.
2 For 15mm rod
3 Handle can be adjusted for portrait or landscape shots.
4 Front and back double cold shoe mount with stop block.

D Freestyle handle

1 Dovetail plate
2 15mm rod hole
3 Compatible with TLTA 15mm dovetail plate.

E Baseplate

1 Handle can be 360 degree adjusted with the adaptor.

F Recording Handle + Rotation Adaptor

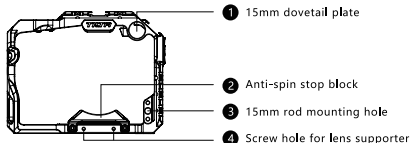

<Front>

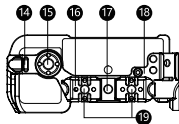

<Top>

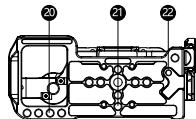

<Base>

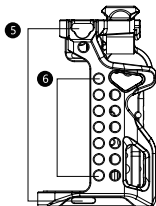

<Left Arm>

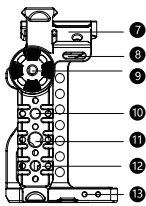

<Right Arm>

- 5 For wrist strap
- 6 1/4 screw hole
[For tripod quick release plate]
- 7 Cold shoe mount
[For microphone, lighting etc.]
- 8 For safety strap
- 9 Standard Arri rosette
[For top handle or extension handle etc.]
- 10 1/4 screw hole [For HDMI adaptor]
- 11 Standard Arri mounting hole
- 12 NATO slot
[For top or side handle etc.]
- 13 Screw hole for TYPE-C cable clip
- 14 For wrist strap
- 15 Standard Arri mounting hole
[Can be converted to 1/4 screw hole]
- 16 NATO slot
[For top or side handle etc.]
- 17 Cold shoe mount
[For mounting top handle/
cold shoe mount etc.]
- 18 1/4 screw hole
- 19 1/4 screw hole
[For mounting rod adaptor etc.]
- 20 1/4 screw hole
- 21 1/4 screw hole
[For mounting dovetail plate etc.]
- 22 Slotted Screwdriver
[Magnetically attached to the cage]

INSTALLATION

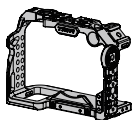

Install SONY A7SIII onto the cage

1

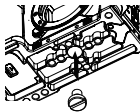

2 Take out the screw from the camera then insert it into the screw hole.

3 Fasten the screw using the magnetic screwdriver.

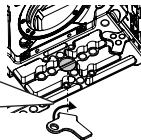
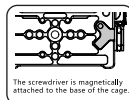

HOW TO INSTALL TOP HANDLE

FUNCTION DEMONSTRATION

Standard Top Handle

[Optional]

By pressing the top button, handle can be switched to different holding position.



Mounting the top handle to the 1/4 screw hole **1**



Fasten the screw **2**



Push down then spin 90 degrees for horizontal position.



Universal Top Handle

[Optional]

Can be quickly attached to the cage, giving you enhanced shooting stability.



Mounting the top handle to the 1/4 screw hole **1**

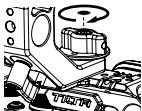

Fasten the screw **2**

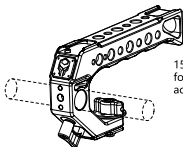

15mm rod hole can be used for mounting EVF and other accessories.

Freestyle handle

[Optional]

Adjust the handle to different positions for portrait or landscape shots.

1

Mounting the top handle onto the Arri rosette.

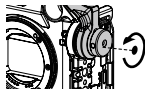

2

Fasten the knob

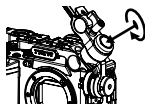

Push down then spin the handle 90 degrees.

[180 degrees portrait mode]

Spin 180 degrees, switch top handle to side handle.

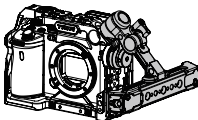

HOW TO INSTALL NATO SLOT

- 1** Attach the NATO slot onto the 1/4 screw holes.

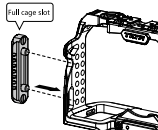

- 2** Fasten the screws

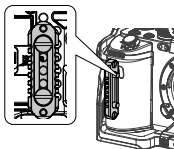

HOW TO INSTALL CABLE CLIPS

- 1** Attach the cable clips onto the 1/4 screw holes.

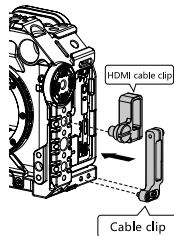

- 2** Fasten the screws

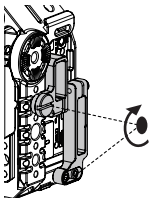

HOW TO INSTALL RECORDING HANDLE AND NATO ADAPTOR

- 1** Attach the NATO adaptor onto the 1/4 screw hole.

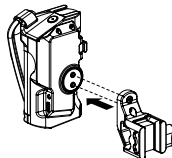

Press the button for 360-degree adjustment.

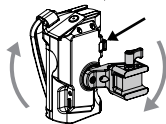

- 2**

Loosen the screw on the NATO adaptor then slide the handle into the slot.

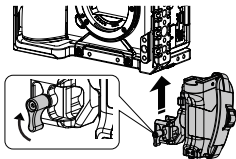

- 3**

Fasten the screw

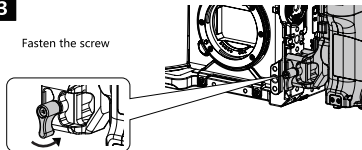

The nominal voltage for the recording handle is 8V and 12V. Please do not exceed. Damages caused by inappropriate operation will not be entitled to warranty.

[Wooden handle/Cold shoe/Quick-release plate/ Baseplate]

HOW TO INSTALL WOODEN HANDLE AND COLD SHOE MOUNT

- 1** Loosen the screw on the NATO adaptor, then slide the handle into the slot.



2



Fasten the screw

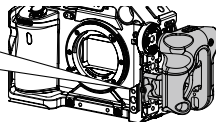

3



Attach the cold shoe mount onto the 1/4 screw hole

4



Fasten the screw

QUICK-RELEASE PLATE/ BASEPLATE INSTALLATION

1

Mounting the universal plate onto the 1/4 screw holes.

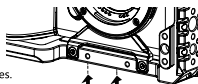

<Universal sliding plate>

Same mounting position for Arca and Manfrotto plates.



2

Fasten the screw

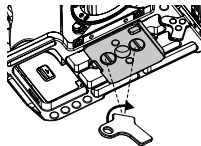



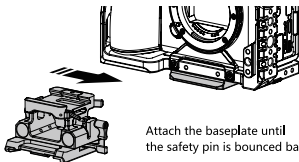













3



Attach the baseplate until the safety pin is bounced back.

//// BUILD YOUR VERY OWN SONY A7SIII CAGE

 <p>TA-T18-HCC Half Cage</p>	 <p>TA-QRTH Quick Release Handle</p>	 <p>TA-QRTH5 Standard top handle</p>	 <p>TA-QRTH4 Freestyle handle</p>
 <p>TA-LRH-57 / TA-AHA6-L Tilting Side Advanced Power Handle</p>	 <p>TA-RWH / TA-AHA6-R Tilting Side Wooden Handle</p>	 <p>TA-T18-CC2 1/8" Thread Cable Clamp Attachment</p>	 <p>TA-T18-CC1 USB-C Cable Clamp Attachment</p>
 <p>TA-SRA-15 15mm Side Single Rod Holder</p>	 <p>TA-BSP2-15 Tilting 15mm LWS Baseplate</p>	 <p>TA-T37-LAS PL Mount Lens Adapter Support</p>	 <p>TA-NRA-36 Tilting 36mm NATO Rail Attachment</p>
 <p>TA-T18-BP Bottom Plate</p>	 <p>TA-T18-QRBP3 Manfrotto Quick Release Plate</p>	 <p>TA-T18-QRBP4 ARCA Quick Release Plate</p>	 <p>TA-CSR Cold Shoe</p>