

ARM YOUR CAMERA

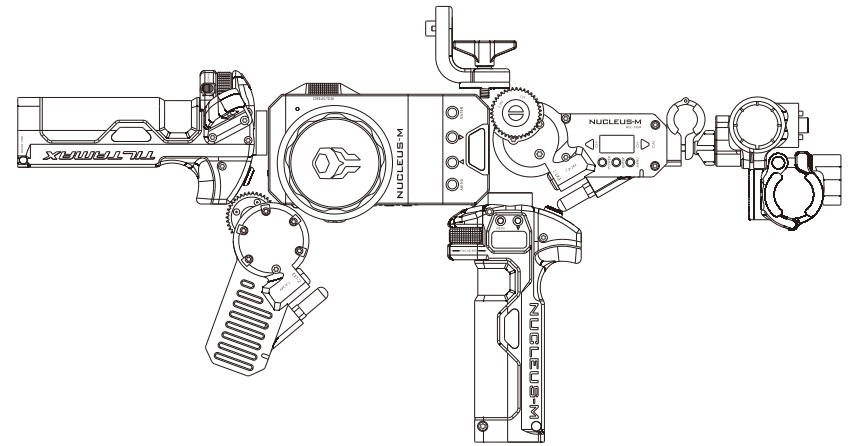

< USER GUIDE >

Nucleus-M Wireless Follow Focus System

TILTA TECHNOLOGY CO., LTD

TEL:+86-0755-33185005

Fax:+86-0755-33185003

Add: 2nd Floor, Building B, Qiaode High Technology Park,
Road No.7, Guangming New Dist, Shenzhen, 518125

TILTA INC. (UNITED STATES)

TEL: +1 (818) 561-4991

Address: 2801 W Magnolia Blvd. Burbank, California, 91505

WWW.TILTA.COM

Product Overview:

The Tiltamax Nucleus-M Wireless Follow Focus System:

Made for industry professionals

Quick, Easy, and Reliable precision control of Focus, Iris, and Zoom

Compatible with Cine Lenses and Photo Lenses

Ambidextrous FIZ Unit design

Ergonomic Handle grips

Low Noise High Torque Motors

Compact and Modular

Multi-Channel System

EZ Mode (Quick Pairing)

Make sure you turn on all the equipment

Press ▲▼ on FIZ hand unit at the same time to enter EZ Mode

```
EZ Mode RF +id
Channel:00
UP/DOWN +- Channel
ENTER      Start
```

Press [CH+] [CH-] on the motor which controls the focus

```
EZ Mode
EXT1=01 MOTOR
EXT2=00 MOTOR
```

Press [MENU] and ▼ on right handle and left handle

```
EZ Mode
```

Then choose the channel that you need by pressing ▲▼ on the FIZ Hand unit.

The motors start searching

The screen will show as below after the search is completed

```
EZ Mode RF +id
Channel:01
Handle R+L
T03M 1+2
```

"R"+"L" means right handle and left handle, two handles are now connected
"1"+"2" means Motor No.1 and Motor No.2, two motors are now connected

Press ENTER to confirm
Now, all the equipment should be in the same channel
The motor which controls the Focus will be automatically matched to the same channel as the FIZ hand unit

Disclaimer:

1. Please read this disclaimer before use
2. User is responsible for operation and consequences of operation
3. Tiltax is not responsible for any modification made by the user to software or hardware which may cause immediate or prolonged immeasurable damage to the unit
4. For additional troubleshooting please call us at:

International: +86 4006 1998 67

North America: +1 818 561 4991

FCC Statement:

This equipment has been tested and found to comply with the limits for a Class B digital device, pursuant to Part 15 of the FCC Rules. These limits are designed to provide reasonable protection against harmful interference in a residential installation. This equipment generates uses and can radiate radio frequency energy and, if not installed and used in accordance with the instructions, may cause harmful interference to radio communications. However, there is no guarantee that interference will not occur in a particular installation. If this equipment does cause harmful interference to radio or television reception, which can be determined by turning the equipment off and on, the user is encouraged to try to correct the interference by one or more of the following measures:

- Reorient or relocate the receiving antenna
- Increase the separation between the equipment and receiver
- Connect the equipment into an outlet on a circuit different from that to which the receiver is connected
- Consult the dealer or an experienced radio/TV technician for help









Changes or modifications not expressly approved by the party responsible for compliance could void the user's authority to operate the equipment

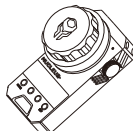
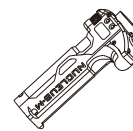
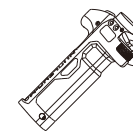
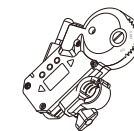

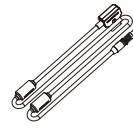
Technical Specifications

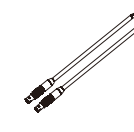
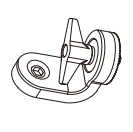
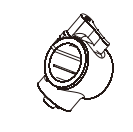
Total Weight	4167g (including battery handle)	Case Size	330*280*150mm
FIZ Hand Unit	Dimensions	142*90.5*70mm (L*W*H)	
	Weight (with battery)	430g	
	Operating Frequency	2.4G	
	Max Transmission Distance	Main handwheel 150-300M, handle 75-150M, maximum distance with amplifier 2000M	
	Emission Power	30MW~100MW /100MW~800MW (Additional Long Distance Module)	
	Current	0.15A	
	Voltage	7.2V EXT. 7.2V~14.8V	
	Battery Type	18650	
	Operating Temperature Range	-20°C~+50°C	
Ideal Environment	Dry Climates. Avoid condensation in high humidity.		
Motor	Dimensions	114*92*30.7mm (L*W*H)	
	Weight (with battery)	225g	
	Operating Frequency	2.4G	
	Max Receiving Distance	500M (unobstructed and upgradeable to 2000M)	
	Emission Power	30MW~100MW / 10MW~800MW (Additional Long Distance Module)	
	Current	Quiescent Current : 0.10A/14.8V Conventional Current : 0.5A/14.8V	
		Locked Rotor Torque Current: 2.8A/14.8V	
	Voltage	7.2V~24V	
	Rod Compatibility	15mm/19mm	
	Noise	15db	
	Gear	Module: 0.8 Teeth: 39	
	Operating Temperature Range	-20°C~+50°C	
	Ideal Environment	Dry Climates. Avoid condensation in high humidity	
Handles	Dimensions	85*59.5*175.5 mm (L*W*H) (including thumb unit) 85*31*175.5 mm (L*W*H) (not including thumb unit)	
	Weight (with battery)	340g / 355g (including thumb unit)	
	Current	0.1A	
	Voltage	Battery: 7.2V EXT : 7.2V~14.8V	
	Battery Type	18650	
	Operating Frequency	2.4G	
	Emission Power	10MW~100MW	
	Max Transmission Distance	10M~100M	
	Operating Temperature Range	-20°C~+50°C	
	Ideal Environment	Dry Climates. Avoid condensation in high humidity	

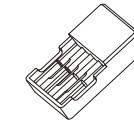
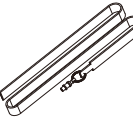
Standard Packing List

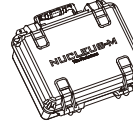
			 X2
FIZ Wireless Hand Unit	Left Wireless Handle	Right Wireless Handle	Wireless Motor
 X4			
Follow Focus Marking Disk	740mm P-TAP Power Cable	Straight 180mm Motor Cable	Straight 296mm Motor Cable
 X2	 X2	 X2	
Handle to Arri Standard Rosette Adaptor	Handle to Gimbal Bar Adaptor (25mm/30mm diameter)	Follow Focus Ring	Battery Charger
	 X2		
FIZ Unit Lanyard	Motor Antenna	Waterproof Safety Case	

Optional Accessories

For More Information Please Visit: www.tilta.com

- Quick Release Handgrip Bridge
- Left Handle Thumb Joystick Unit
- 740mm P-TAP Power Cable
- Wireless Motor
- Nucleus-N Motor
- 740mm 2pin Lemo Cable 740mm
- Run/Stop Cable
- Universal Gimbal Ring Adaptor w/ Rosette
- 3Pin Fischer Cable
- Follow Focus Marking Disk
- Battery Charger
- Straight 296mm Motor Cable
- Motor Antenna
- 18650 Battery Flight Case
- Straight 180mm Motor Cable
- 0.4/0.5/0.6 Gear
- Follow Focus Ring x2
- Long Distance Wireless Module

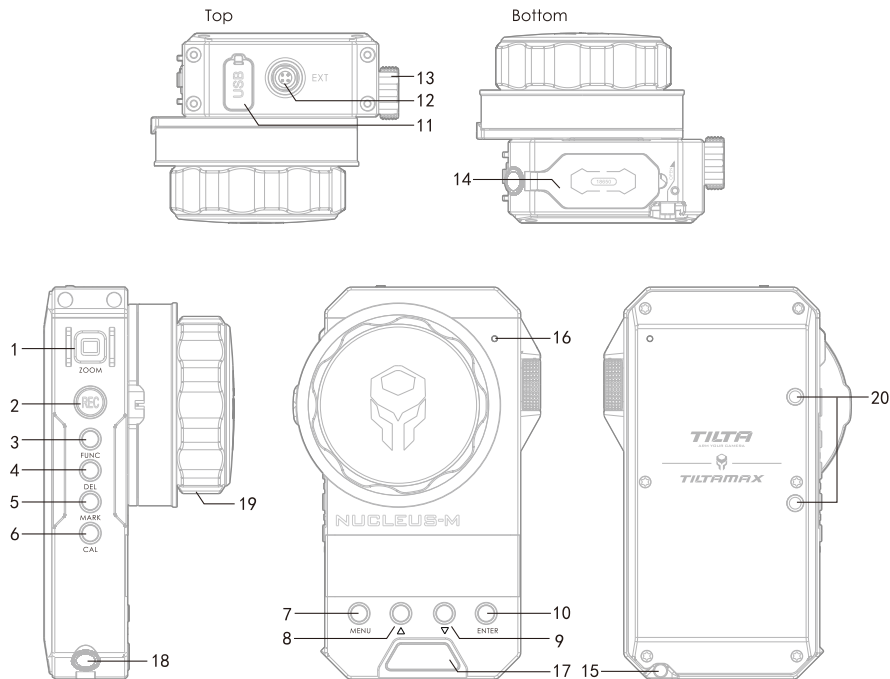

Transmitter:

- | | |
|--|--|
| <ul style="list-style-type: none"> 01. ZOOM Joystick
Zoom Controller 02. REC Button
Activate Run/Stop 03. FUNCTION Button 04. DELETE Button 05. MARKER Button
Make Marks 06. CALIBRATE Button
Hold to Calibrate Range of Lens 07. MENU Button
Enter Main Menu 08. UP Button ▲
Upward Selection 09. DOWN Button ▼
Downward Selection 10. ENTER Button | <ul style="list-style-type: none"> 11. USB port
For Data Transfer and Updating Firmware 12. EXT port
Power and Communication In/Out 13. IRIS Wheel
Iris Controller and Controls Zoom Speed 14. 18650 Battery Compartment Latch 15. Battery Compartment Button
Push to open Battery Compartment latch 16. Light Sensor
Adjusts Key LED and Screen Brightness 17. POWER Button 18. Lanyard Attachment 19. FOCUS Knob
Focus Controller 20. Attachment Bracket |
|--|--|

FIZ Unit

Firmware updates are first downloaded to the FIZ Unit by connecting it to a Mac or PC via MicroUSB cable. The FIZ unit will appear on the computer as an external drive called, "Tilta." Drag the files into the FIZ and unplug. Now follow the images below to update the FIZ Unit itself

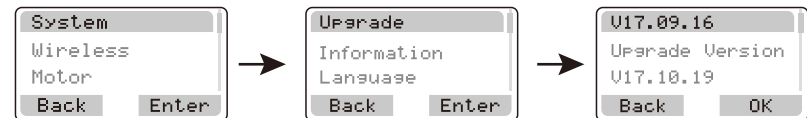

Handles

Use the 7-pin to 7-pin LEMO cable to connect the FIZ to a Handle and on the FIZ, repeat the following steps to update the Handle. Repeat this process for the other handle



Motors

Use the 7-pin to 7-pin LEMO cable to connect the FIZ to a Motor and on the FIZ, repeat the following steps to update the Motor. Repeat this process for the other motors



You are able to control the motors and their specifications by TILTA APP instead of handwheel and handles

This function will be available later through APP

For more information on the: Nucleus-M Wireless Follow Focus System
Visit the product page on our website: www.tilta.com

Double click **[MENU]** , select " Joystick SPD. ", double click **[MENU]** to enter, and use ▼ to select Joystick SPEED - values from 1-99, with 99 being the fastest and 1 being the slowest setting

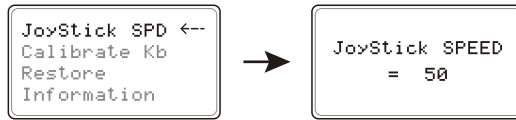

9. ZOOM/SPEED

When Motor No. on the Knob is "0", the Knob is used as the Speed Controller for the Zoom



When Knob is assigned a Motor Number from 1 thru 4, speed must be changed in the menu; however a snap zoom or "Zip" can still be performed by holding down the front **[AB]** - this will instantaneously multiply the current speed value by 5 when using the Zoom Joystick



10. Factory Reset

Double click **[MENU]** , select "RESTORE", double click to **[ENTER]** . Double click ▼ to restore to factory default settings



11. Calibrate Handle Knob

⚠ When does the Handle Knob need calibration ?

- 1) If the motor spins one way then rapidly spins the other way in the same instance
- 2) If the Knob is completely rotated to the end and the Knob Rotation Value on the display is not at 000 or 999

Double click **[MENU]** ,select "Calibrate Kb", and double click **[MENU]** to enter. Follow the on screen directions. Rotate the Knob clockwise to the end for "Minimal", then confirm with double clicking ▼

Repeat the previous steps for the second calibration

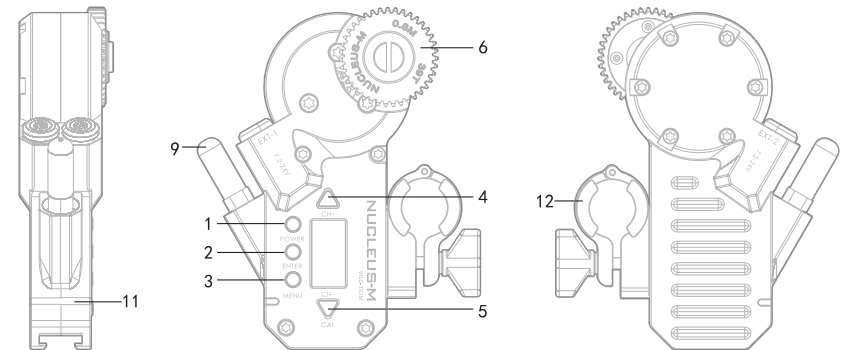
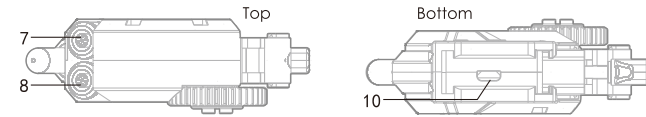

Receiver:

- 01. POWER Button
Turn on/off
- 02. ENTER Button
Confirm Selection
- 03. MENU Button
Enter Main Menu
- 04. UP Button and CHANNEL +
Upward Selection and Increase Channel Number
- 05. DOWN Button and CHANNEL -
Downward Selection and Decrease Channel Number
- 06. 0.8 Gear
Connects to Lens Gear to Adjust Focus, Iris, or Zoom
- 07. EXT-2 Port
Power and Communication In/Out
- 08. EXT-1 Port
Power and Communication In/Out
- 09. Wireless Antenna
Receives Wireless Signal
- 10. Micro USB Port
For Data Transfer and Updating Firmware
- 11. Indicator Light
Indicates Status of Motor
- 12. 15/19mm Rod Adapter
Compatible via 15mm Bushing

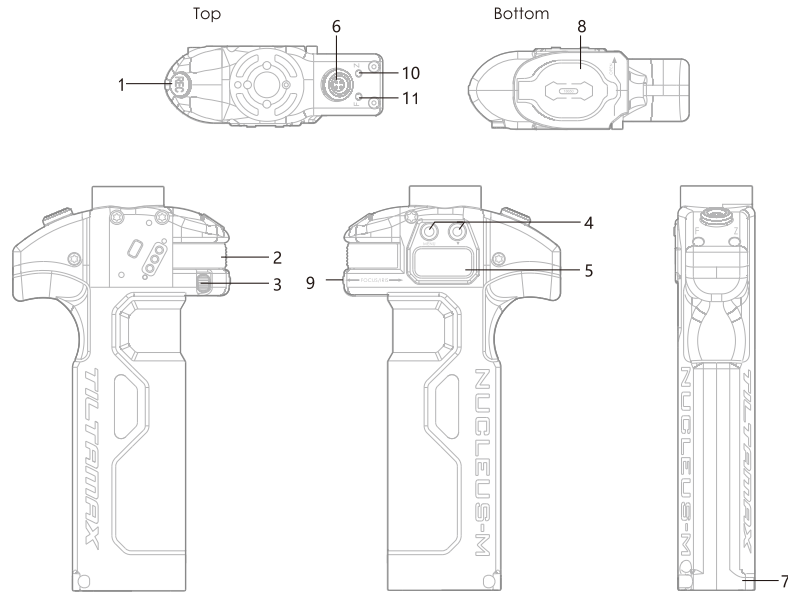

Controller:

- | | |
|--|--|
| 01. RECORD Button
Activate Run/Stop | 07. Battery Compartment Button
Push to open Battery Compartment Latch |
| 02. FOCUS / IRIS Knob | 08. 18650 Battery Compartment Latch |
| 03. Knob Degree Adjustment Switch
Rotation Settings: 85, 180, 310 Degrees | 09. A-B Marker Button
Creating Close Focus and Infinity Focus Marks |
| 04. MENU Button
Enter Main Menu | 10. Z LED
Joystick LED Indicator |
| 05. LCD Display | 11. F LED
Knob LED Indicator |
| 06. EXT Port
Power and Communication In/Out | |

Optional: Left Handle Thumb Joystick Unit

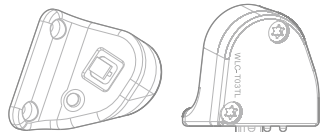

5. Knob Torque

Double click **[MENU]** ,and use the ▼ to select "Knob torque" 30%,50%,90% different Knob Motor Torques can be selected

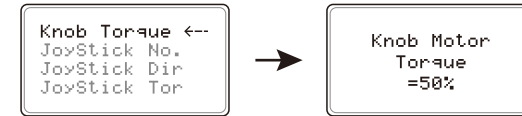

6. Knob Motor Control Number

Double click **[MENU]** , select " Knob No. " , double click MENU Button to enter , and use ▼ to select Motor Number. Setting Knob No. to "0" prevents a signal transmission



7. Knob Motor Direction

Double click **[MENU]** , select "Knob Dir. " , double click **[MENU]** to enter , and use ▼ to select Knob Motor Direction. " CW " is " Clockwise. " " CCW " is " Counter Clockwise "



8. Joystick

Double click **[MENU]** , select "Joystick No. " , double click **[MENU]** to enter , and use ▼ to select Joystick Motor Control No. - setting Joystick No. to " 0 " prevents a signal transmission



Double click **[MENU]** , select " Joystick Dir. " , double click **[MENU]** to enter , and use ▼ to select Joystick Motor Direction. " CW " is " Clockwise. " " CCW " is " Counter-Clockwise "



Double click **[MENU]** , select " Joystick Tor. " , double click **[MENU]** to enter , and use ▼ to select Joystick Motor Torque: 30%, 50%, or 90%



5. Motor Information

Double click MENU, select "INFORMATION" to check Motor Information

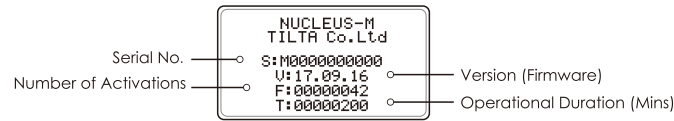

6. Factory Reset

Double click [MENU], select "RESTORE", [ENTER], double click ▼ to confirm

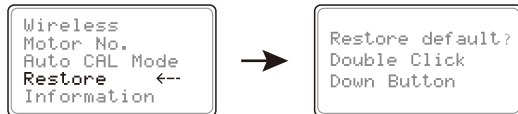

Handles

1. Home Screen

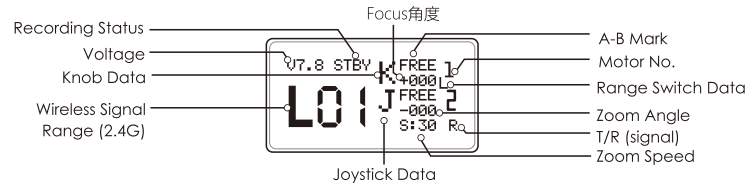

2. Setting the 2.4G

Double click [MENU] select "Wireless", [ENTER] and select 2.4G with ▼. Press [REC] to return to the Home Screen

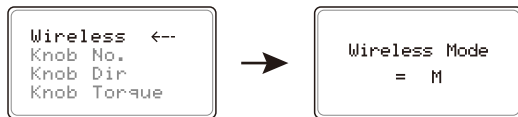

3. Changing the Channel

Double click [MENU] select "Channel", [ENTER] and select Channel Number with the ▼, Press [REC] to return to the Home Screen

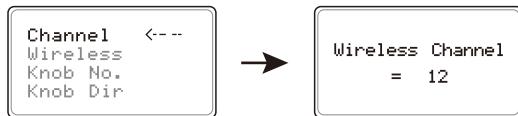

4. Run / Stop

Properly attach a Run/Stop cable. Click [REC] on the top of the Handle. If "STBY" on the display changes to [REC], the recording has commenced

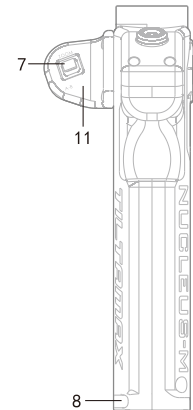
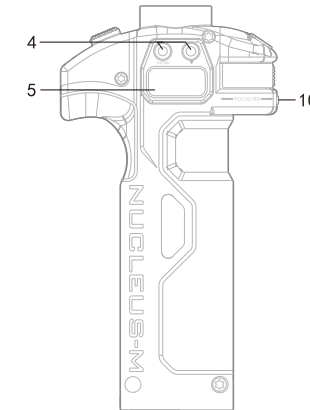
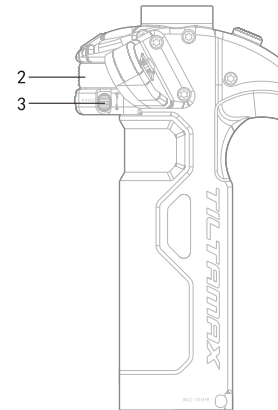
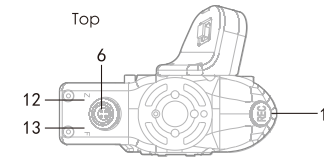
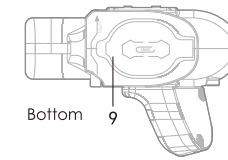
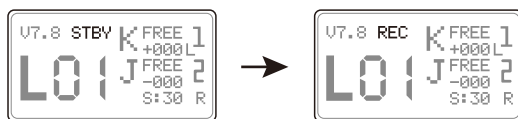

Controller :

- 01. RECORD Button
Activate Run/Stop
- 02. FOCUS / IRIS Knob
- 03. Knob Degree Adjustment Switch
3 Rotation Settings: 85, 180, 310Degrees
- 04. MENU Button
Enter Main Menu
- 05. LCD Display
- 06. EXT Port
Power and Communication In/Out
- 07. ZOOM Joystick
ZOOM Distance can be control
- 08. Battery Compartment Button
Push to open Battery Compartment Latch
- 09. 18650 Battery Compartment Latch
- 10. Knob A-B Marker Button
Creating Close Focus and Infinity Focus Marks
- 11. Joystick A-B Marker Button
Creating Close Focus and Infinity Focus Marks
- 12. Z LED
Joystick LED Indicator
- 13. F LED
Knob LED Indicator

Attaching the Motor to a DSLR Camera

Add the follow focus ring to the lens. Secure it tightly. Make sure the fastener is not in a position where the motor's gear will hit it during it's calibration run.

Once the follow focus ring is on the lens, follow the same steps for calibration as if it were a cine lens

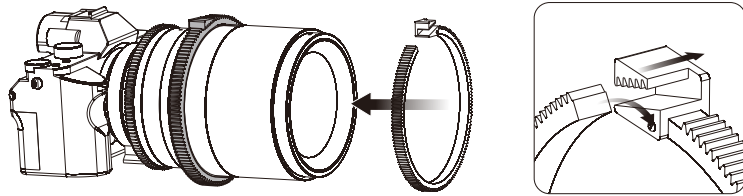

Note: If the lens already has a 0.8 gear or has been modified to have one, then the motor can be attached and calibration can begin just as if it were a cine lens

Inserting the Batteries

Installing the Batteries in the FIZ

Hold the FIZ Unit. Push the **Open** .
The battery compartment latch will release.
Place (2) 18650 Batteries in any direction
and then close the latch

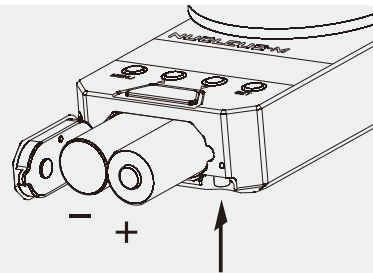

Installing the Batteries in the Handles

Hold the Handle. Push the **Open** .
The battery compartment latch will release.
Place (2) 18650 Batteries in any direction -
as long as positive and negative ends on
the batteries touch - and then close the latch

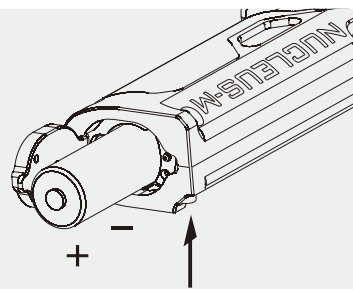

10. Calibrate FIZ Knob

Click the **MENU** , highlight "FUNCTION", and click **ENTER** . Highlight " Calibrate Knob" and **ENTER** . Follow the on screen directions. Rotate the Knob clockwise to the end for "Minimal", then confirm with **ENTER** . Repeat the process until FIZ Knob calibrates

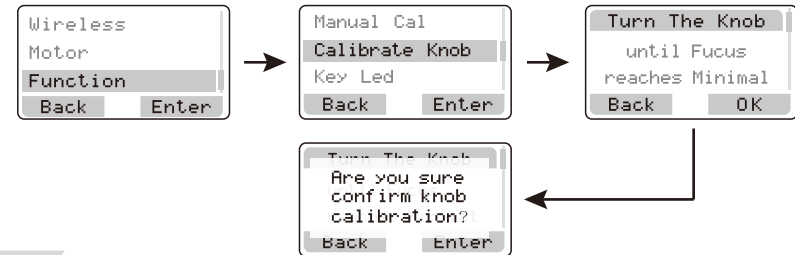

Motor

1. Home Screen

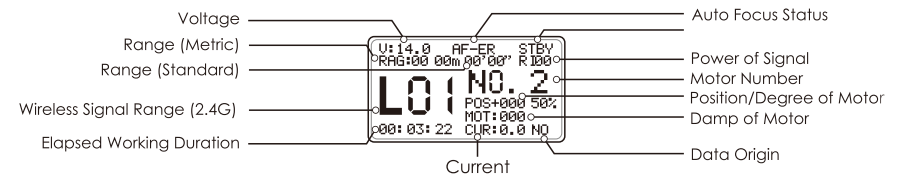

2. Setting 2.4G

Double click the **MENU** , select "Wireless", **ENTER** Button, and use the **▲▼** to pick between the 2.4G settings

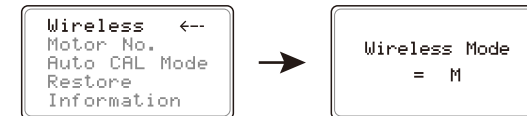

3. Changing Channel

Double click the **CH-** to decrease the Channel number or double click the **CH+** to increase the Channel number

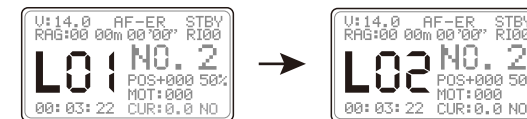

4. Changing Motor Number

Double click the **MENU** , select "Motor No.", **ENTER** , and use the **▲▼** to assign a Motor Number

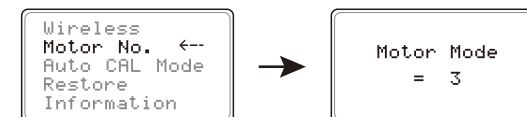

② Setting and Deleting Marks

The FIZ unit can create up to 10 "soft" marks. Rotate the Focus Knob to the desired mark. Double click the **[MARK]** on the side of the FIZ Unit to set a mark. The mark will appear as a letter. Rotate the Focus Knob to the next desired position and then double click the **[MARK]** to create another marker. Vibrations will occur when marks are passed along the Focus pull. Double clicking the **[DEL]** will erase markers in reverse alphabetical order

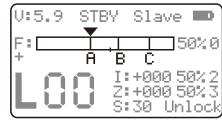

8. Factory Reset

Press the **[MENU]** , highlight "System", **[ENTER]** , highlight "Factory Reset", and **[ENTER]**

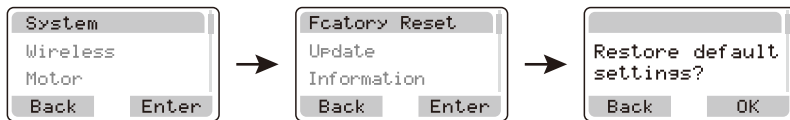

9. Adjusting the Zoom with the Speed Controller Setting

Set the Iris to "0" by having no Motor No. synced to the Iris controller on the FIZ. The Home Screen will now show an "S" where "I" used to be. "S" refers to speed. Now the speed of the Zoom controller can be changed by spinning the Iris wheel controller on the FIZ

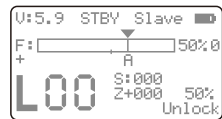

If the Iris is set to a Motor No. of 1-4, speed can be controlled by double clicking **▲▼** . The speed range will increase or decrease by increments of 1 with a range from 1-99, where 99 is the fastest and 1 is the slowest setting

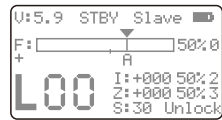

To perform a snap zoom or "ZIP", hold down **▲** while using the Zoom Joystick Zoom, hold **▼** while using the Zoom Joystick, dividing the current speed value by 10

⚠ When does the FIZ Knob need calibration ?

- 1) If the FIZ Knob has been rotated to end and this icon:  does not reach the end of the display bar
- 2) If the motor spins one way then rapidly spins the other way in the same instance

Nucleus-M: Shoulder Mount Assembly

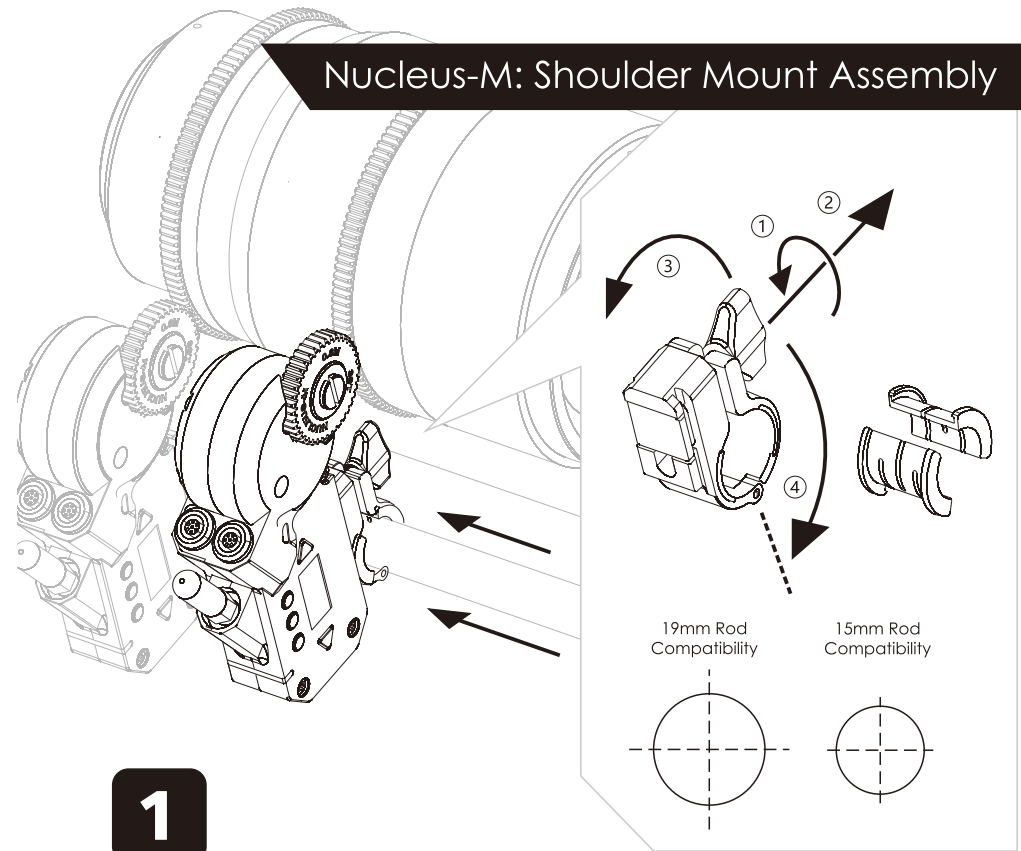

1

Slide the Motor into position under the lens gear. Bushing allows for 19mm to 15mm compatibility

2

1. Loosen knob on Rod Adapter
2. Adjust the position of the Motor
3. Embrace the Motor Gear with the Lens Gear snugly
4. Tighten the knob on Rod Adaptor

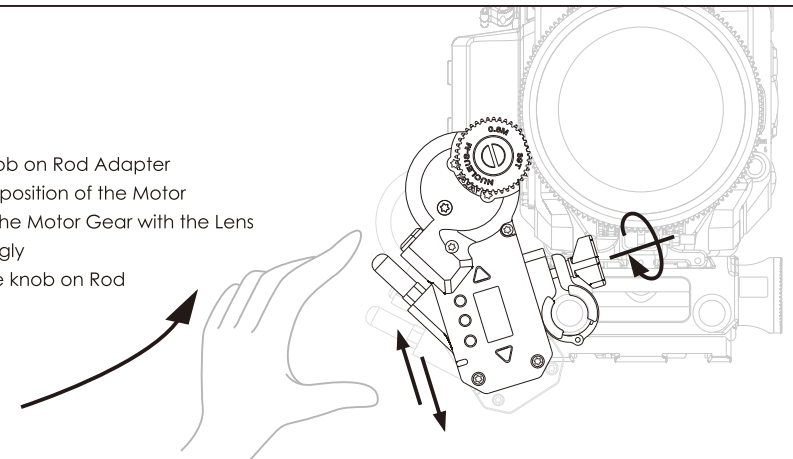

Motor: Power Supply and Run/Stop

Each Motor has (1) EXT-1 port and (1) EXT-2 port
Both ports can Power In/Out as well as control Run/Stop

1. Power can be sent directly to the Motor and/or daisy-chained from Motor to Motor



2. A single cable can be used to power the motor and activate the camera's R/S, if the camera port is capable of power out and R/S - such as the 3-pin LEMO ports on the Tilta Alexa Mini and RED DSMC2 Cages

For Example :
ARRI XT-RS port
TILTA FOR ALEXA MINI Cage -14.8v 3pin R/S port
TILTA FOR RED DSMC2 Cage -14.8v 3pin R/S port

If Camera Port is not capable of both R/S and Power out, then separate cables must be used to achieve motor power supply and R/S (see image below)

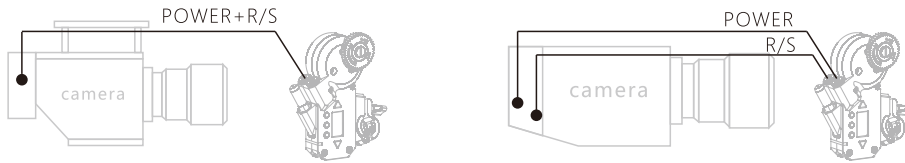

3

1. Connect Motor to Motor via motor connection cable through its EXT-1 to the other motor's EXT-2 port
2. Use the P-TAP cable to provide power from the battery to a motor through its EXT-1 port

* Use either the straight 296mm cable or the straight 180mm cable to connect the motors according to your needs

Warning: If the motors are already connected to the camera through a R/S with Power Output port (as seen in Fig 1) an additional power cable will cause the motors to shut down

5. Changing the Torque of Motors

Click on the **[MENU]** to enter the menu system. Use **▲▼** to highlight "Motor" and **[ENTER]**. Highlight "Focus", **[ENTER]**. Highlight "Torque", **[ENTER]**. Three options will appear: High, Medium, and Low - highlight and select the desired Torque value. Click enter and a confirmation will appear as a check mark. Press the **[MENU]** till the Home Screen appears

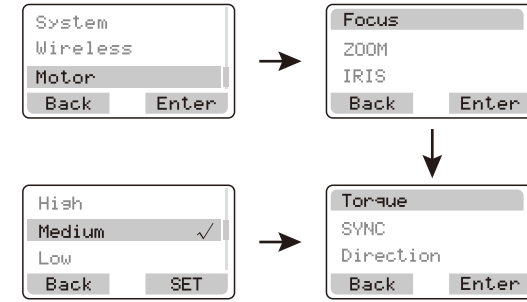

6. Syncing the Motor

Click on **[MENU]** enter the menu system. Use **▲▼** to highlight "Motor" and **[ENTER]**. Highlight "Focus", **[ENTER]**. Highlight "SYNC", **[ENTER]**. Three options will appear: Motor 1, Motor 2, Motor 3 - highlight and select the desired Motor. Click enter and a confirmation will appear as a check mark. Press **[MENU]** till the Home Screen appears

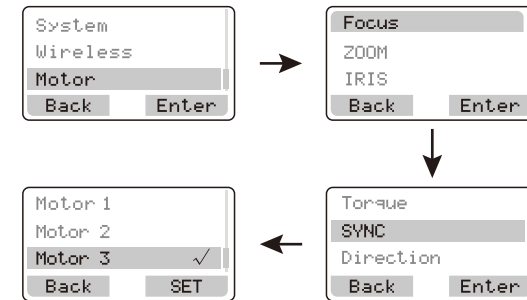

7. Setting Hard Stops / Limits

Hard Stops/ Limits can be made on the FIZ unit. Position the Knob to the desired **[A]** Mark. Hold down **[MARK]**. With the **[MARK]** held down, rotate the Knob to the desired **[B]** Mark. Release **[MARK]** when finished. Confirmation is defined by a vibration. The limited range selected will expand to the entire throw of the Knob. Below the limited range is identified by the white bar. Hold the **[DEL]** to delete the Hard Stops /Limits

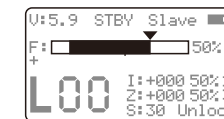

FIZ Hand Unit

1. Home Screen

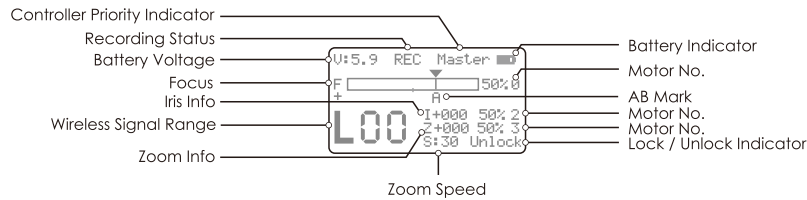

2. Change the Language

Click on **[MENU]** to enter the menu system. Use **▲▼** to highlight "System". Highlight "Language" and choose the language as needed by clicking **[ENTER]**. A confirmation will appear as a check mark. Push **[MENU]** repeatedly to return to the Home Screen

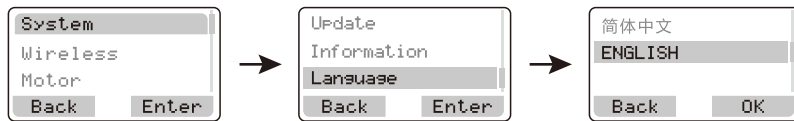

3. 2.4G and CHANNEL

Click on **[MENU]** to enter the menu system. Use **▲▼** to highlight "Wireless". Highlight "2.4G". Pressing **[ENTER]** will change the 2.4G Setting. Use **▼** to change the Channel; Use **▼** to change the the High, Medium, and Low Torque value

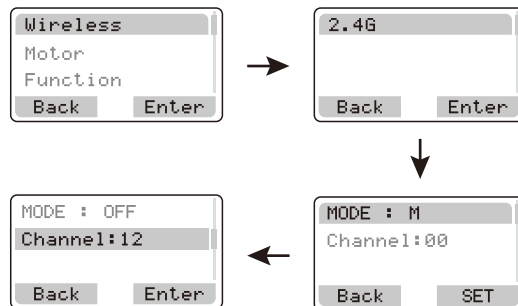

4. Run/Stop

Properly attach the R/S cable to the camera. Click **REC** on the left side of the FIZ Unit. On the display, "STBY" will turn into **REC**. A vibration will notify the AC that recording has begun

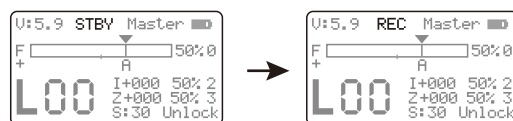

4

1. Attach the Handgrip Bridge to the Rods
2. Lock down the bridge connection via tightening screw disk

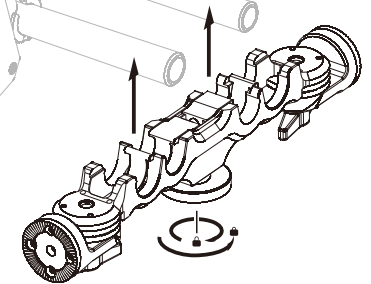
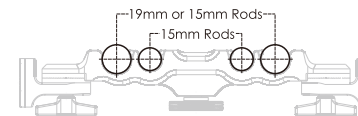

5

The Handle to Arri Standard Rosette Adaptor connects to the Quick Release Handgrip Bridge and any other accessory with Arri Standard Rosettes

1. Use Allen Key to screw down the Arri Standard Rosette Adaptor into the Handle
2. Attach Arri Standard Rosette from Handle to the Quick Release Handgrip Bridge and secure connection via large thumb screw

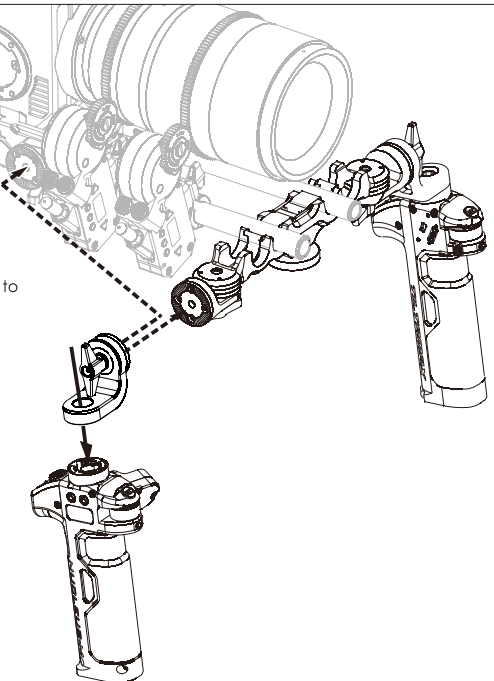

Nucleus-M: Gravity Gimbal and Drone Assembly

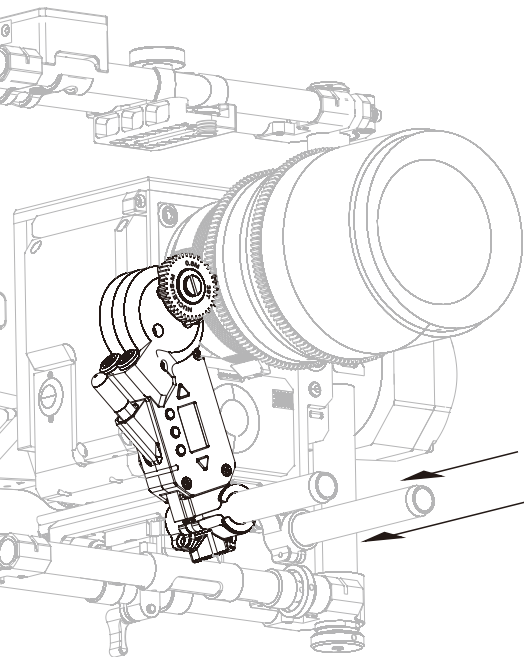

1

1. Slide the Motors into position under the lens gear. When using the Nucleus-M on a gimbal or drone it is recommend to place one motor on each side to maintain the camera's equilibrium

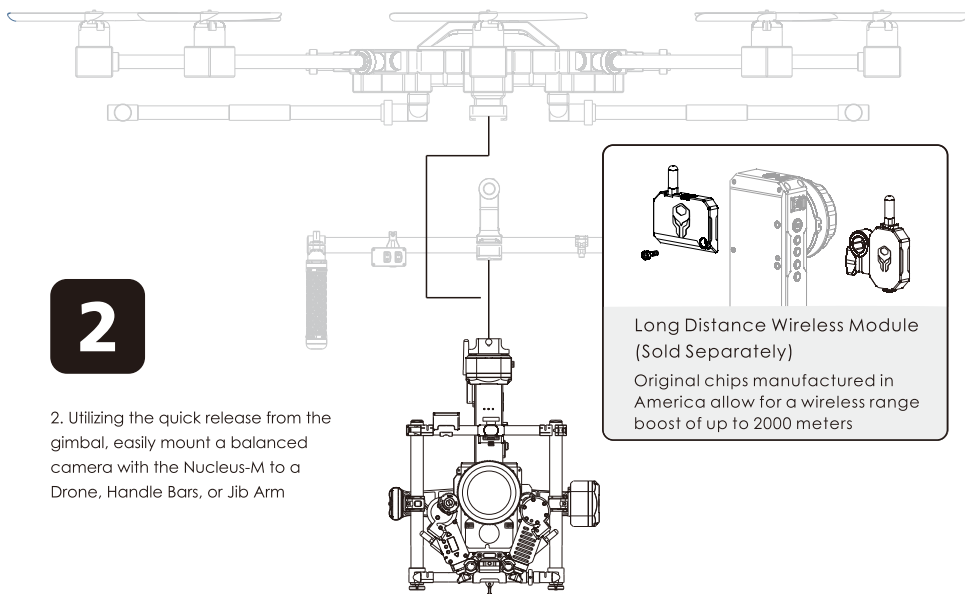
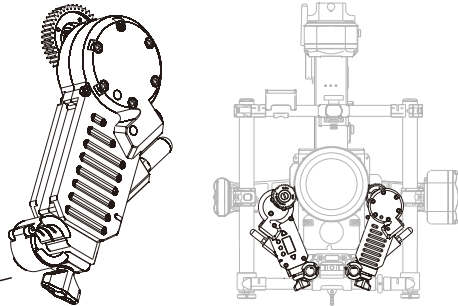

2

2. Utilizing the quick release from the gimbal, easily mount a balanced camera with the Nucleus-M to a Drone, Handle Bars, or Jib Arm

Long Distance Wireless Module (Sold Separately)
Original chips manufactured in America allow for a wireless range boost of up to 2000 meters

2. Creating and Deleting Hard Stops from the Handle

2.1 Creating Hard Stops / Limits via Knob controller

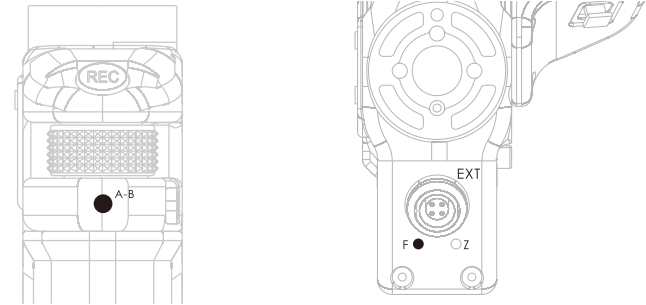

Hard stops can be set on the Handles' Knob. Rotate the Knob and double click on the front **[AB]** to set **[A]** Mark. The mark has been confirmed when the "F" LED blinks green. Rotate the Knob to the next mark and double click **[AB]** to set a **[B]** Mark. The "F" LED will glow solid green. Now the full 310 degree throw of the Knob controller will reflect **[A]** to **[B]** Mark. To delete the hard stops, double click on **[AB]** again. The "F" LED will turn off



2.2 Hard Stops / Limits via Thumb Unit / Joystick controller

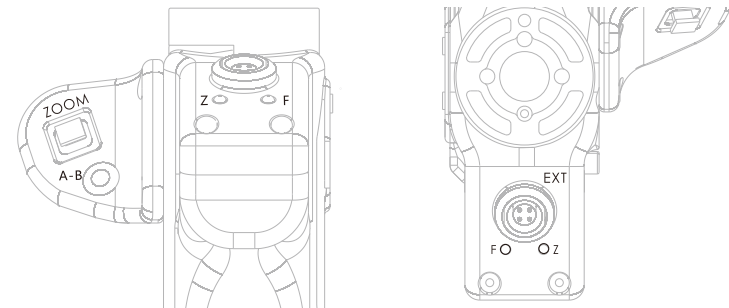

Hard stops can be set on the Handles' Joystick. Position the joystick and double click on the thumb unit's **[AB]** to set **[A]** Mark. The mark has been confirmed when the "Z" LED blinks red. Position the joystick to the next mark and double click **[AB]** to set a **[B]** Mark. The "Z" LED will glow solid red. Now the full throw of the Joystick controller will reflect the **[A]** to **[B]** Mark. To delete the hard stops, double click on **[AB]** again. The "F" LED will turn off. On the Joystick, the speed from which **[A]** to **[B]** Marks are reached is determined by the Speed controller, when Iris has been assigned to "0"



Setting the Range & Hard Stops on Handles

1. Setting the Rotation Degree on the Knob

Some lenses have long focus throws. To compensate for this, the Handle's knob can be set to various rotational degrees. Both the left and right handles can change their rotational degrees. Shortening the knob's rotational degrees will shorten long focus throws by making the motor speed up and vice-versa: long knob degrees can be used on short focus throws. There are 3 ranges that can be chosen. The following directions pertain to the Right Handle. When using the Left Handle inverse the spin direction

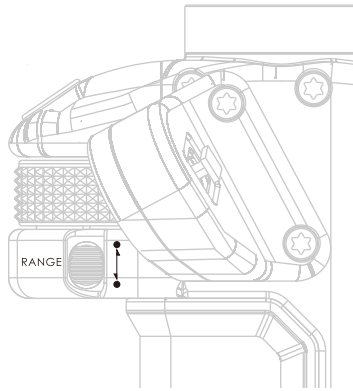
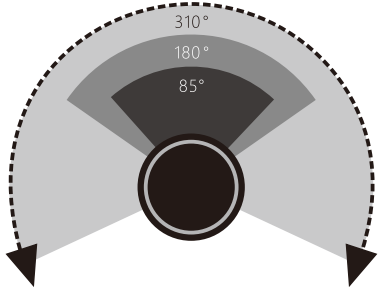

Pull **[RANGE]** ↓. The letter "L" will appear on the Handle's display. "L" or "Long" sets the knob to the longest distance it can rotate from left to right, 310 degrees. The motor will move slowly in this setting



Pull **[RANGE]** ↓. The letter "L" will appear on the Handle's display. Spin the Knob clockwise completely till the knob stops. Push **[RANGE]** ↑. The letter "S" will appear on the Handle's display. "S" or "Short" sets the knob to the shortest rotational distance, 85 degrees



Pull **[RANGE]** ↓. The letter "L" will appear on the Handle's display. Spin the Knob counter clockwise completely till the knob stops. Push **[RANGE]** ↑. The letter "M" will appear on the Handle's display. "M" or "Medium" sets the knob to 180 degrees



Handle to Gimbal Bar Assembly

3.1

1. Use Allen Key to screw down the Gimbal Bar Adaptor into the Handle
2. Attach Gimbal Bar Adaptor from Handle to the Gravity Gimbal Bar and secure connection via thumb screw

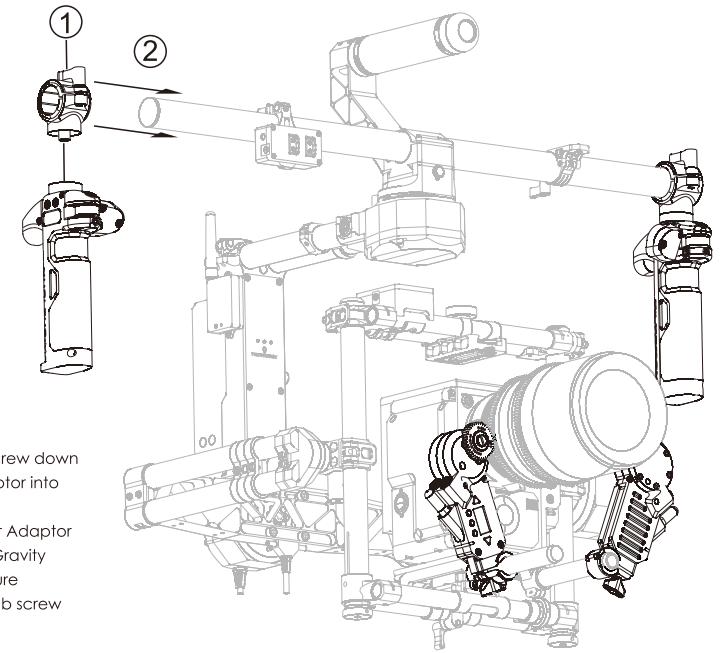

Handle to Universal Gimbal Adaptor with Rosette Assembly

3.2

1. Use Allen Key to screw down the Arri Standard Rosette Adaptor into the Handle. Attach Arri Standard Rosette from Handle to the Universal Gimbal Adaptor with Rosette and secure connection via large thumb screw
2. Attach Universal Gimbal Adaptor to Gimbal Ring. Repeat for opposite side

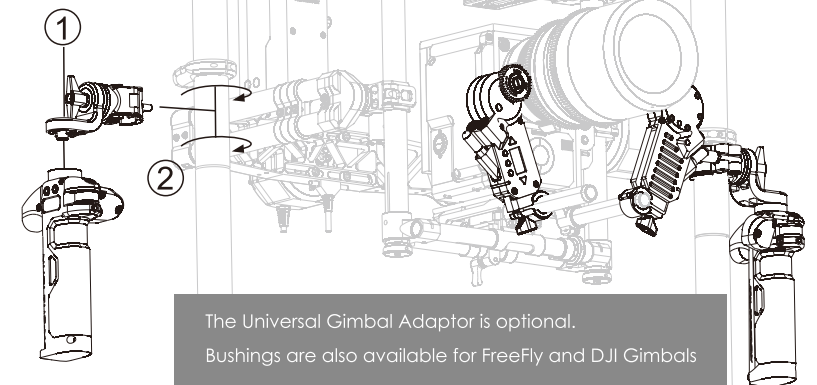

The Universal Gimbal Adaptor is optional.
Bushings are also available for FreeFly and DJI Gimbals

How to Use: Nucleus-M

Turn On / Turn Off

1. FIZ Hand Unit

Turn-On — Hold **[POWER]** to Open the Main Menu

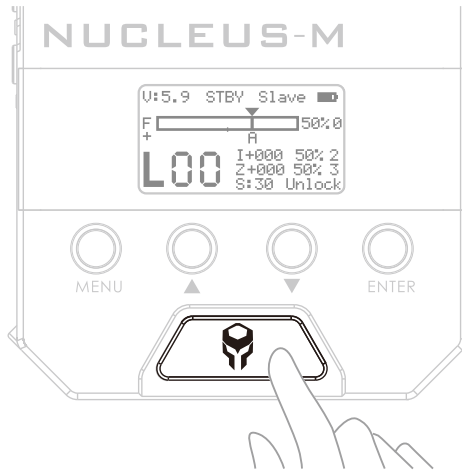

Turn-Off — 1.1 Hold **[POWER]** then release. Use **▲▼** to toggle between selections.

Double Click **[POWER]** to confirm

1.2 Hold **[POWER]** Down for 3 Seconds and then the designated unit will shutdown

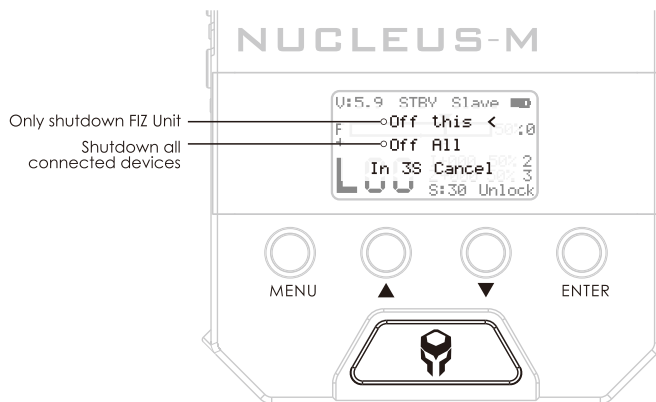

2. Calibrating from the Motor

2.1 Setting the Auto CAL Mode

When the Motor is powered on, the following screen may appear.

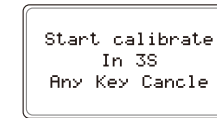

This screen is dependent on the "Auto CAL Mode." This auto calibration setting can be found in the Motor's menu. Use **▼** to select "Auto CAL Mode" - toggle between the 3 options pictured below

The **"Manual Start"** setting will prevent the Motor from calibrating when initially turned on

The **"Auto Start After 3 Secs"** setting will automatically trigger calibration after 3 seconds when initially turned on. The user has 3 seconds to press any button on the motor to cancel the calibration

The **"Auto Start Immediately"** setting will immediately trigger calibration from the Motor the moment it turns on

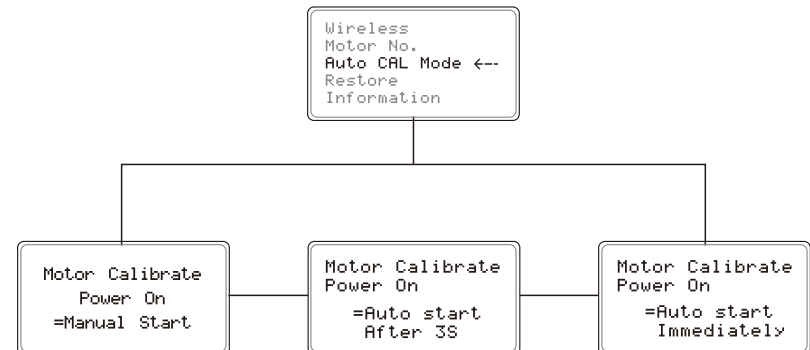

Once a calibration mode has been selected the Motor will turn red and calibration will begin. When the Motor's LED turns white, calibration has finished

2.2 Single and Multi-Motor Calibration from the Motor

Calibration from the Motor can happen at anytime, simply hold down **[CAL]** and release. Two options will appear: "CALIBRATE THIS" and "CALIBRATE ALL". "CALIBRATE THIS" will begin calibration on only the motor being programmed. "CALIBRATE ALL" will begin calibration on all motor's daisy-chained to it. Double click **[CAL]** to confirm and the motor(s) will begin calibration

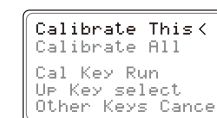

CALIBRATION

1. Calibration from the FIZ Unit

1.1 Calibration of Lens with Hard Stops

When using cine lenses or modified photo-lenses with follow focus gears and hard stops, calibrate from the FIZ unit by holding down **[CAL]**. The screen will show a 3 second countdown. Holding down **[CAL]** on the motor will also trigger a calibration

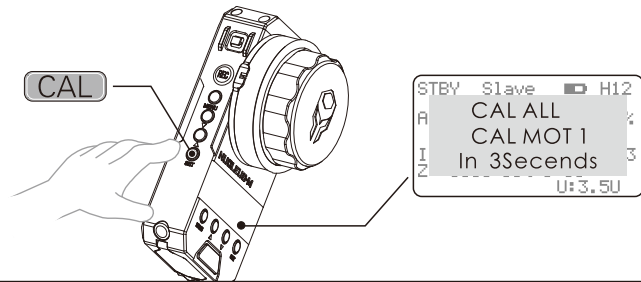

Note : By default the Motors are set to the "Manual Start" - Auto CAL Mode. Motors need to be set the "Auto Start" Mode and calibrate on a lens before the CAL Button can be used on the FIZ and Handles. Doing so in this order will prevent any damage to the lens

1.2 Calibration of Lens without Hard Stops

Lenses without hard stops need to be manually calibrated. Follow the images below to set manual calibration from the FIZ. For this example, we will calibrate **[Focus]**

- 1) Be sure that the Motor is not making contact with the lens gear
- 2) Turn the FIZ knob so that it is in the middle of its range
- 3) Now, manually position the lens gear to "middle" focus position between close and infinity
- 4) Securely attach the Motor to the lenses focus gear
- 5) Take the FIZ Unit and press the MENU Button to open the menu system
- 6) Highlight and select "FUNCTION"
- 7) Select "MANUAL CAL". Three options will appear: FOCUS, ZOOM, IRIS
- 8) Choose the one in need of calibration according to your needs- in this case select Focus
- 9) Follow the directions on the screen. Turn the knob completely counterclockwise and select enter. This sets the close focus
- 10) Now follow the directions on the screen once more. Turn the knob completely clockwise, the Motor should pull the lens gear to infinity. Select OK and return to the Main Menu. The Focus should now be properly calibrated

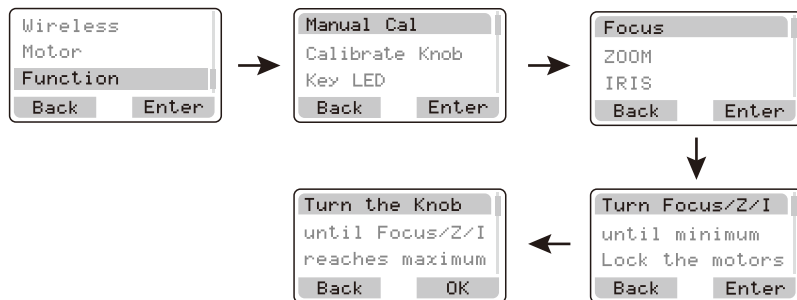

2. Motor

Turn-on — Hold **[POWER]** to Open Main Menu

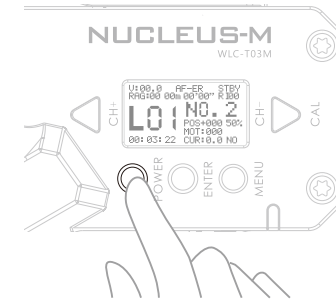

Turn-off — 1.1 Hold **[POWER]** then release, choose the mode
Double click **[POWER]** to confirm

1.2 Hold **[POWER]** Down for 3 Seconds and then the designated unit will shutdown

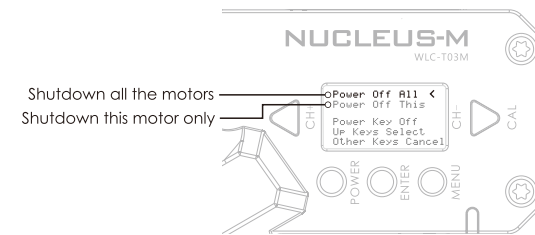

3. Handle

Turn-on — Hold **[REC]** to Open Main Menu

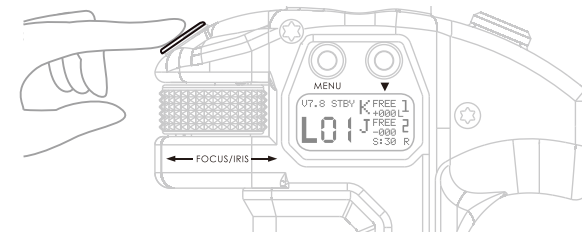

Turn-off — Hold **[REC]** Down for 3 Seconds and then the designated unit will shutdown

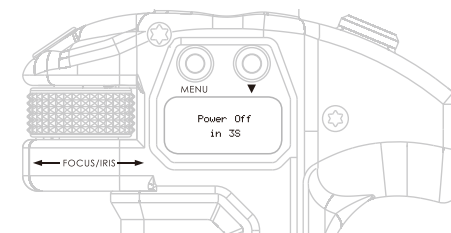

Syncing FIZ Hand Unit with Motors

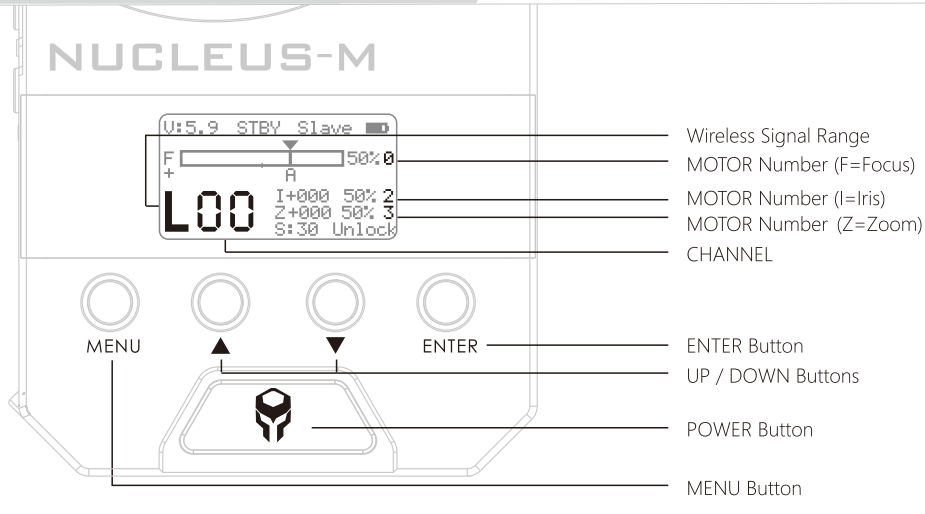

Note: The FIZ Unit Channel Number must Match one of the daisy-chained Motor Channels. The FIZ Unit defaults to MASTER mode. To use the Handles, set FIZ Unit to SLAVE mode.

1. Setting the FIZ Unit's Channel

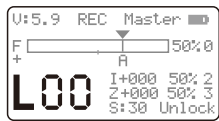

1. From the Home Screen, use **[MENU]** to open the Menu System

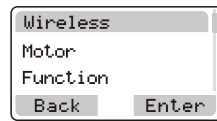

2. Use **▲▼** to highlight "WIRELESS"-press **[ENTER]** to confirm

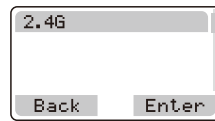

3. With "2.4G" highlighted, press **[ENTER]** to confirm



4. Continue pressing **[ENTER]** until "M" is selected. This value represents the "2.4G" or Long Range Value:

H MAX: Furthest Wireless Distance, High Power Consumption

M Medium: Recommended Wireless Distance, Average Power Consumption

L MIN: Short Wireless Distance, Low Power Consumption

OFF: No Wireless Signal Transmitted used when hardwiring FIZ to Motor



5. Highlight CHANNEL by pressing **▼**, then use **▲▼** to change the Channel Number. Available Channels range from 00-15. Set the CHANNEL to "02"

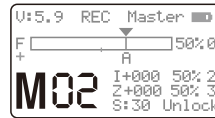

6. Press **[MENU]** to return to the Home Screen. If the screen looks like the image above then the FIZ Unit's Channel has been set

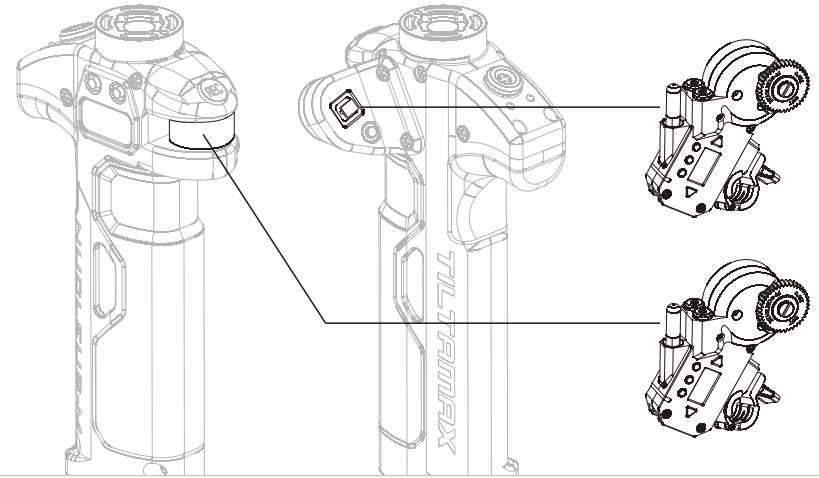

2. Assigning Handle's Knob to Motor

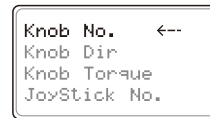

1. From the Home Screen, double click **[MENU]** to open the Menu System. Use **▲▼** to select "KNOB NO." - double click **[MENU]** to confirm

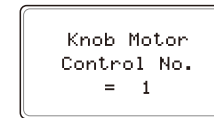

2. When a Motor has been assigned a Motor No., that number corresponds to the value that can be selected by the Handle's Controller. Thus, the Knob Motor Control No. will sync the Motor assigned that number between 1 and 4. Using a value of "0" prevents any controller connection to a motor.

In this case, set the Knob Motor Control No. to 1



3. Use **[REC]** to return to the Home Screen. If the Home Screen appears like the image above, then the Motor has been synced with the Knob

3. Assigning Handle's Joystick to Motor



1. From the Home Screen, double click **[MENU]** to open the Menu System. Use **▲▼** to select "JOYSTICK NO." - double click **[MENU]** to confirm

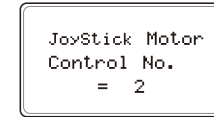

2. When a Motor has been assigned a Motor No., that number corresponds to the value that can be selected by the Handle's Controller. Thus, the Joystick Motor Control No. will sync the Motor assigned that number between 1 and 4. Using a value of "0" prevents any controller connection to a motor

In this case, set the Joystick Motor Control No. to 2



3. Use **[REC]** to return to the Home Screen. If the Home Screen appears like the image above, then the Motor has been synced with the Joystick

Syncing Handles with Motors

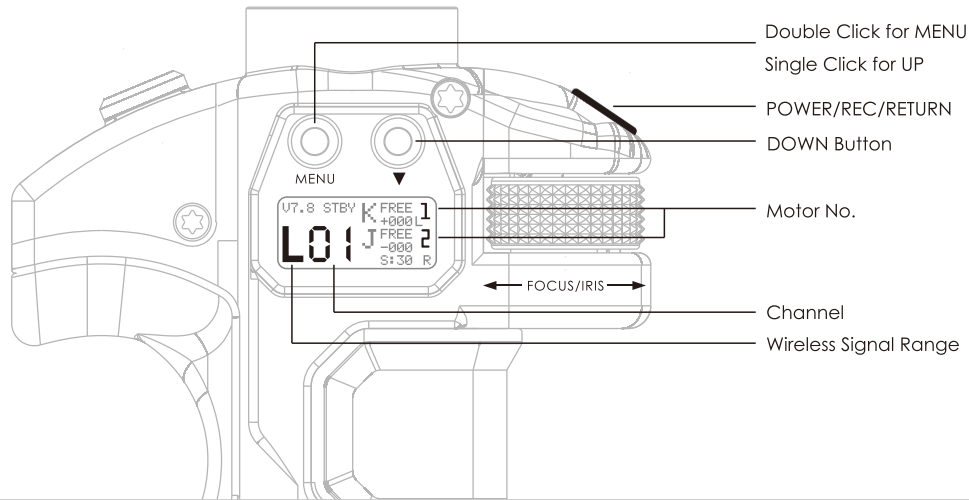

1. Setting the Handle's Channel



1. From the Home Screen, double click **[MENU]** to open the Menu System

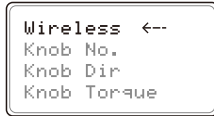

2. Use the **▲▼** to select "WIRELESS" - double click **[MENU]** to confirm

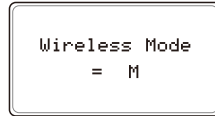

3. Use **▲▼** to select "M". This value represents the "2.4G" or Long Range Value:

- H MAX:** Furthest Wireless Distance, High Power Consumption
- M Medium:** Recommended Wireless Distance, Average Power Consumption
- L Min:** Short Wireless Distance, Low Power Consumption
- OFF:** No Wireless Signal Transmitted For hardwiring to Motor



4. Use **[REC]** to return to the Home Screen. If the Home Screen appears like the image above, then the LORA has been confirmed

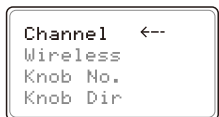

5. Use **▲▼** to select "CHANNEL" - double click **[MENU]** to confirm

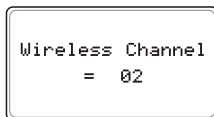

6. Use **▲▼** to change the Channel Number. Available Channels range from 00-15. Set the CHANNEL to "02"

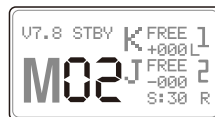

7. Use **▲▼** to return to the Home Screen. If the Home Screen appears like the image above, then the Channel has been confirmed

Below is a Figure for conceptual demonstration purposes depicting a default assignment of the FIZ Unit and 3Motors. Use the example below for quick start and troubleshooting

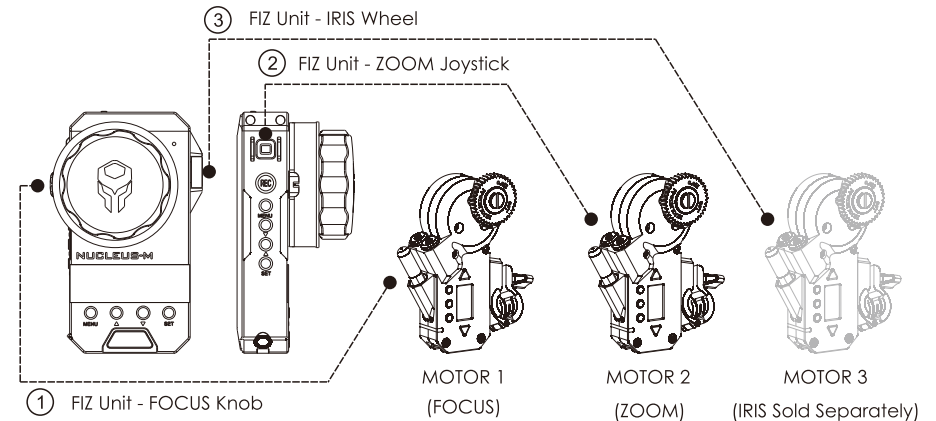

2. Assigning the Motor Numbers to the FIZ Unit

Note: Motors cannot share the same Motor Number. A Motor can identify if its Motor Number is being repeated and will automatically cancel the last Motor Number assigned

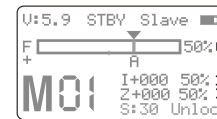

1. Press **[MENU]** to enter the Main Menu

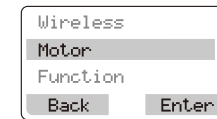

2. Use **▲▼** to highlight "MOTOR" - press **[ENTER]** to confirm

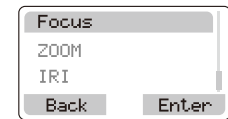

3. Choose the corresponding controller of the FIZ Unit to the designated function of each Motor.

For Example, pair the Motor on the Focus gear of the Lens to the Focus Knob on the FIZ. In this case, that Motor has been assigned as Motor Number 1.

Highlight "FOCUS" and press **[ENTER]**

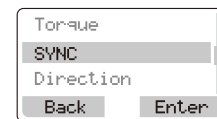

4. Use **▲▼** to highlight "SYNC" - press **[ENTER]** to confirm

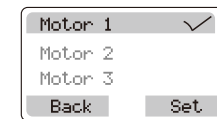

5. Use **▲▼** to highlight "Motor 1" - press **[ENTER]** to confirm.

Confirmation is identified by a check mark. If a Motor Number has no check mark, it is not synced with a controller on the FIZ

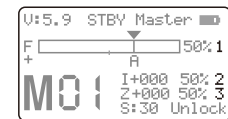

6. Repeat Steps 1 - 5, to assign the Zoom and Iris Motor to the FIZ Unit.

Press **[MENU]** to return to the Home Screen. If the display looks like the picture above, then all 3 Motors have been synced properly

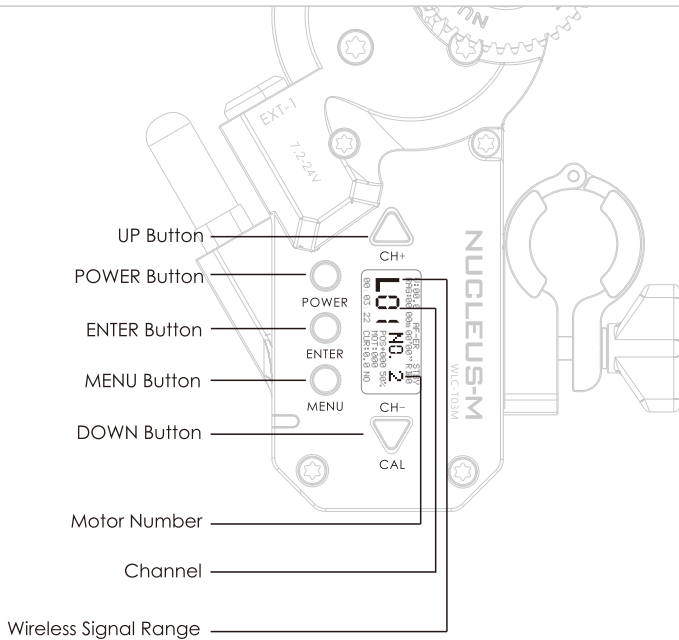

3. Setting the Motor's Channel

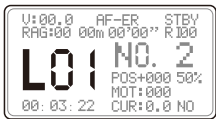

1. From the Home Screen, double click **[MENU]** to open the Menu System

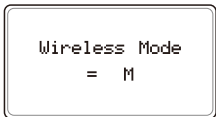

3. Continue pressing **[ENTER]** until "M" is selected. This value represents the "2.4G" or Long Range Value:

- H MAX:** Furthest Wireless Distance, High Power Consumption
- M Medium:** Recommended Wireless Distance, Average Power Consumption
- L MIN:** Short Wireless Distance, Low Power Consumption
- OFF:** No Wireless Signal Transmitted
Used when hardwiring FIZ and/or Handle to Motor(s)

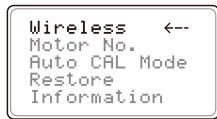

2. Use **▲▼** to highlight "WIRELESS" - double click **[ENTER]** to confirm

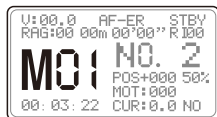

4. Press **[MENU]** to return to the Home Screen

5. Double click **▲▼** to change the channel.

Set the Channel to "01" then press **[MENU]** to return to the Home Screen. If the display looks like the image on the left, then the Motor Channel has been set

4. Setting the Motor's Motor Number

For the purposes of this tutorial, if the Motor is not assigned to Motor No. 1, it will not be synced with the FIZ's focus knob controller

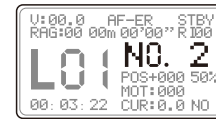

1. From the Home Screen, double click **[MENU]** to open the Menu System

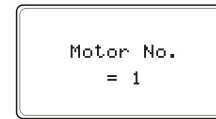

3. Use **▲▼** to assign the Motor a number between 1 and 4.

In this case, set the Motor No. to 1, corresponding to the Focus on the FIZ

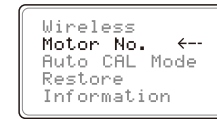

2. Use **▲▼** to highlight "MOTOR NO." - double click **[ENTER]** to confirm

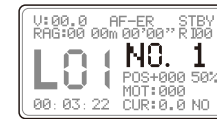

4. Press **[MENU]** to return to the Home Screen. If the display looks like the image above then the Motor Number has been set.

Lastly, repeat the steps above to match the corresponding Motor No. 2 and 3 with the FIZ Unit controller

5. Switching between the FIZ Unit and Handles for Control of Motors

By default the FIZ Unit has priority control over the Motors. To release the FIZ Unit's control and give the Handles priority control, double click on the FIZ Unit's **[FUNC]** . If "SLAVE" appears on the Home Screen display, this is confirmation that the handles now have priority control over the Motors

Recalibration is not necessary, but be sure to assign a controller and do not attempt to control one motor with the FIZ and Handle simultaneously

The FIZ Unit defaults to MASTER mode. To use the Handles, set FIZ Unit to SLAVE mode

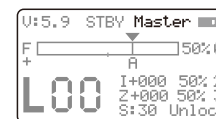

Double Click **[FUNC]** on the FIZ Unit to switch between Master and Slave Modes
When the display reads "Master" the FIZ Unit has priority control over the Motors
When the display reads "Slave" the Handles have priority control over the Motors
For the purposes of this tutorial, let's keep the FIZ in Master mode